

# JIEJIE MICROELECTRONICS CO., LTD.

---

ACJT08.2 813.6 22.08 -18.48 re W n q /GS0 gs 22.079997 0 0 18.47 EMC 3(5)-13.7 (1

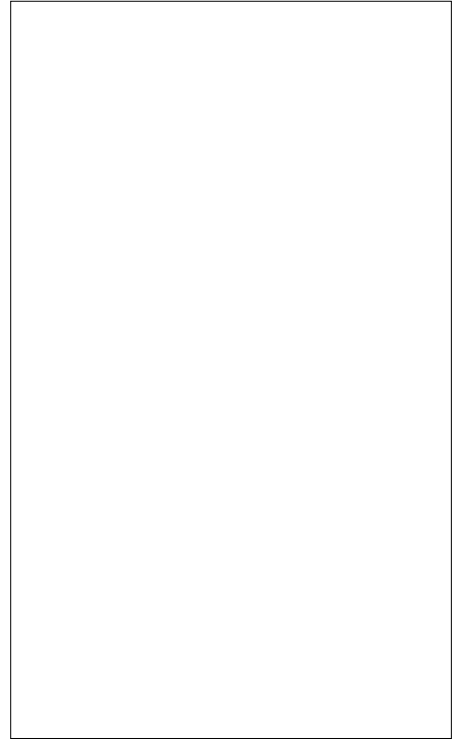



ORDERING INFORMATION

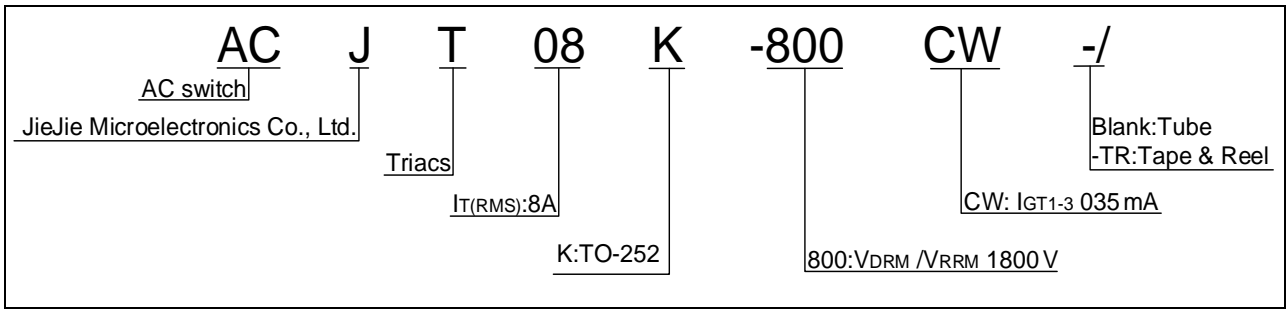

MARKING

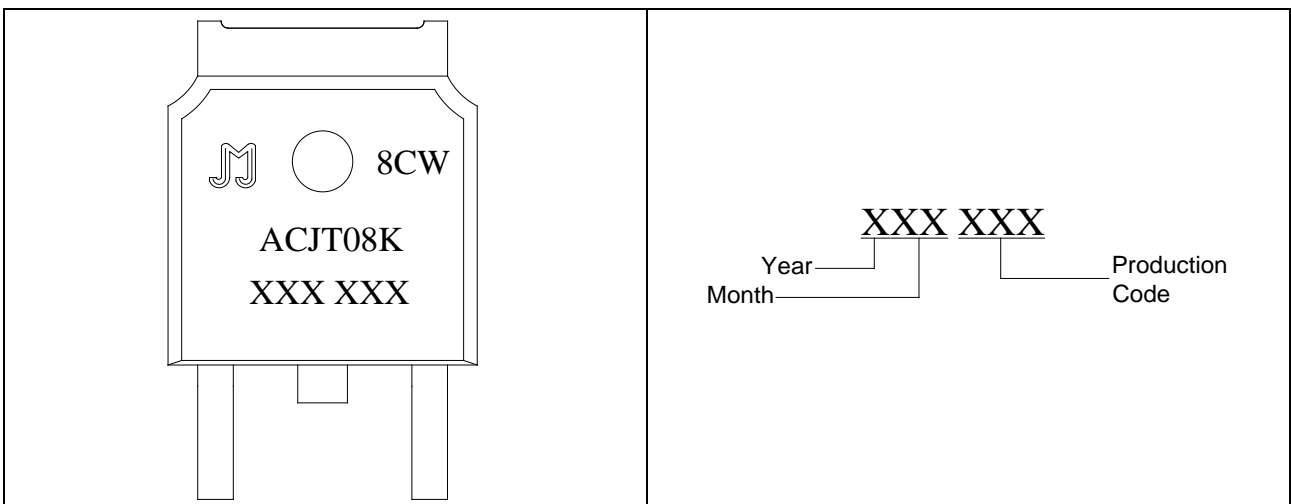

FIG.1: Maximum power dissipation versus RMS on-state current

FIG.2: RMS on-state current versus case temperature

FIG.7: Relative variations of gate trigger current, holding current and latching current versus junction temperature

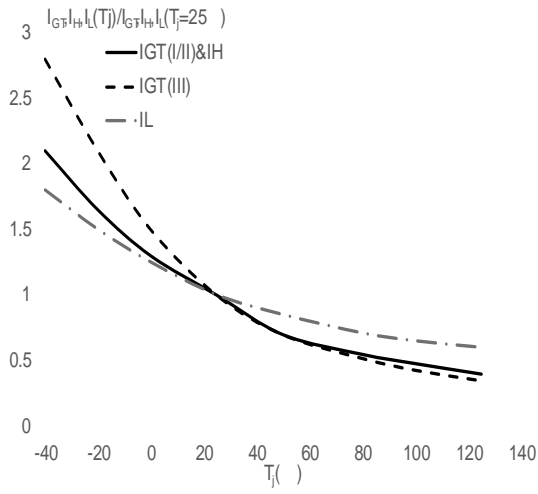
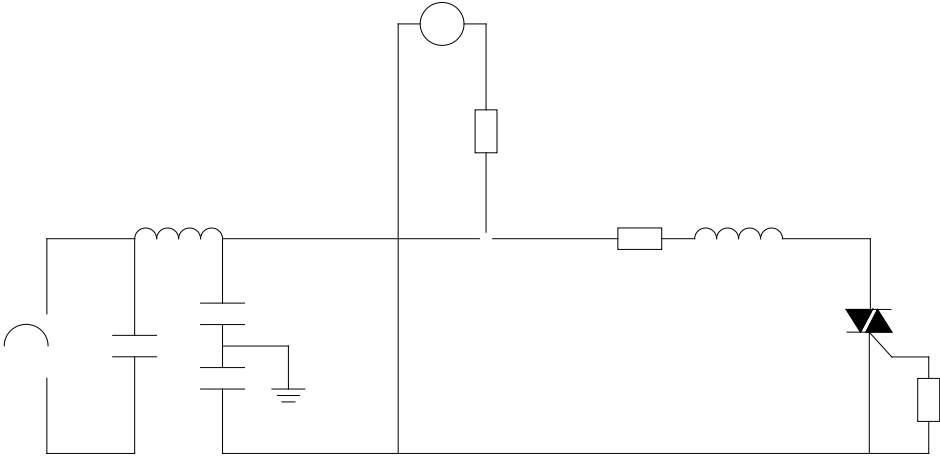

FIG.8 ÖTest circuit for inductive and resistive loads to IEC-61000-4-5 standards



ORDERING INFORMATION

Order code	Voltage V
------------	--------------

PACKAGE MECHANICAL DATA

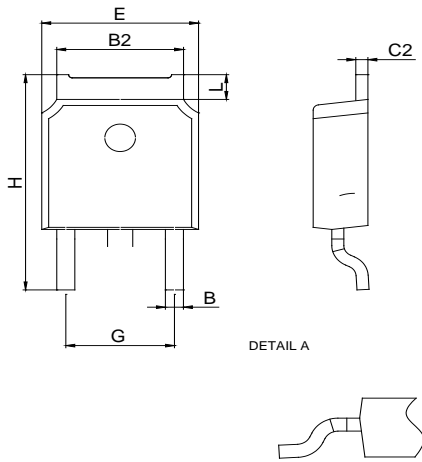

Ref.	Dimensions					
	Millimeters			Inches		
	Min.	Typ.	Max.	Min.	Typ.	Max.
A	2.10		2.50	0.083		0.098
A2	0		0.15	0		0.006
B	0.66		0.86	0.026		0.034
B2	5.18		5.48	0.202		0.216
C	0.40		0.60	0.016		0.024
C2	0.44		0.58	0.017		0.023
D	5.90		6.30	0.232		0.248
D1						
E	6.40		6.80	0.252		0.268
E1	4.63			0.182		
G	4.47		4.67	0.176		0.184
G1	2.18		2.38	0.086		0.094
L	1.09		1.21	0.043		0.048
L2	1.35		1.65	0.053		0.065

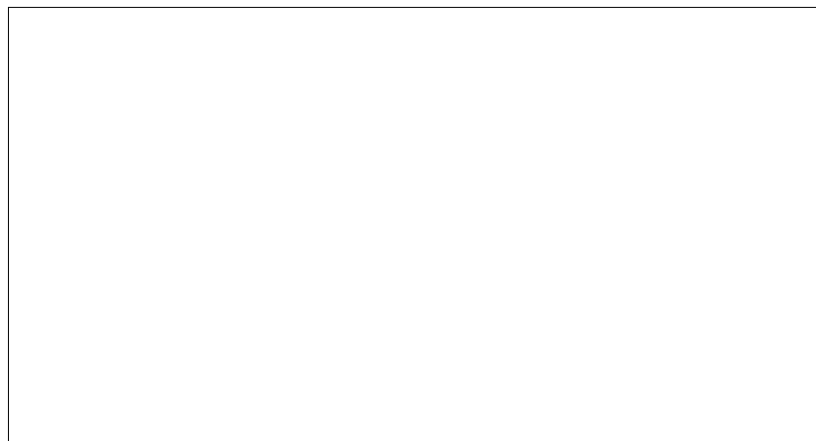

DELIVERY MODE

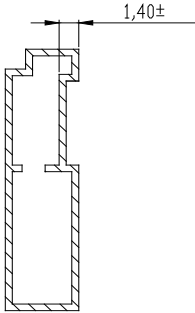

Information furnished in this document is believed to be accurate and reliable. However, Jiangsu JieJie Microelectronics Co., Ltd. assumes no responsibility for the consequences of use without consideration for such information nor use beyond it. Information mentioned in this document is subject to change without notice, apart from that when an agreement is signed, Jiangsu JieJie complies with the agreement.

Products and information provided in this document have no infringement of patents. Jiangsu JieJie assumes no responsibility for any infringement of other rights of third parties which may result from the use of such products and information. This document supersedes and replaces all information previously supplied.

is a registered trademark of Jiangsu JieJie Microelectronics Co., Ltd.  
Copyright © 2025 Jiangsu JieJie Microelectronics Co., Ltd. All rights reserved.