



- , ( - , ( 0 , & 5 2 ( / ( & 7 5 2 1 , & 6 & 2

/ 7

- 2 & + \$ % / ; 6 H U L H V

5 H Y \$

^ Z / W d / K E W

7 K H S U R G X F W V D U H 0 % G K L

- 2 & + \$ %



- LH - LH 0LFURHOHFWURQL

^K>hd D y/DhD Z 7H/ESAUDWXUH f &

3DUDPHWHU	6\PERO	9DOXH
-----------	--------	-------

8QL

- 2 & + \$ %



- LH - LH 0LFURHOHFWURQL

	, VRODWLRQ 5HVLVWDQFH	5,62	' & 9 a 5 +				
	)ORDWLQJ &DSDFLWDQFH	&,2	9   0+]				S)
6ZLWFKLQJ &KDUDFWHULVWLFV	7ULJJHU /(' &XUUHQW	,)7	9&& 9 92 92/				P\$
	3URSDJJDWLRQ 'HOD\ 7LPH WR /RJLF /RZ	W/	& S)				QV
	3URSDJJDWLRQ 'HOD\ 7LPH WR /RJLF +LJK	W+	5/				
	3XOVH ZLQWK GLVWRUWLRQ	3W 3W+	,) P\$				QV
	&RPPRQ 0RGH 7UDQVLHQW ,PPXQLW\ DW /RJLF +LJK	&0+	9&& 9 ,) P\$ 9&0 9 5/				N9 V
	&RPPRQ 0RGH 7UDQVLHQW ,PPXQLW\ DW /RJLF /RZ	&0/	9&& 9 ,) P\$ 9&0 9 5/				N9 V
	5LVH 7LPH	WU	& S) 5/ & 6 \$B 6\$ AF , \$ C & € @ 2 B 0				QV 6@IC'€

- 2 & + \$ %



-LH-LH 0LFURHOHFWURQL

2XWSXW 3XOO XS 5HVLVW/RU				N	
)DQ 2XW/ DW SHU FKDQQHO		1			77/ /RDGV

KZ Z/E' /E&KZD d/KE

<p>- 2 &amp; + \$ %</p> <p>-LH-LH 0LFURHOHFWURQLFV &amp; R /WG</p> <p>2SWR &amp; RXSOHU</p> <p>+LJK VSHHG</p> <p>6LQJOH 2&amp;</p> <p>9 9&amp;&amp; 9</p>	<p>1RQH 7 5 7</p> <p>1RQH /623 :/623 :</p> <p>0%G KLJK VSHHG</p> <p>7 P\$</p>	%
---	---	---

W I]vP Yμ vš]šÇ	
K% š ]} v	Yμ vš]šÇ
E}v IZ	ïïï hv]š•IZ o

D Z</E'

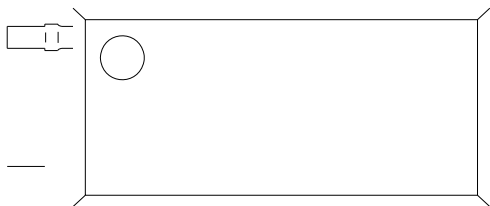



Z Œ š Œ]•š] • μŒÀ •

),\* +LJK /HYHO 2XWSXW &XUUHQW, YV+\$PKLHŒMO 2XWSXW &XUUHQW  
7HP SHUDWXUH 7HP SHUDWXUH

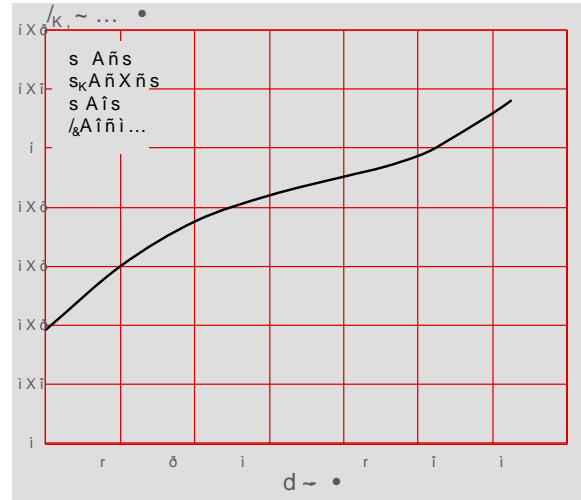
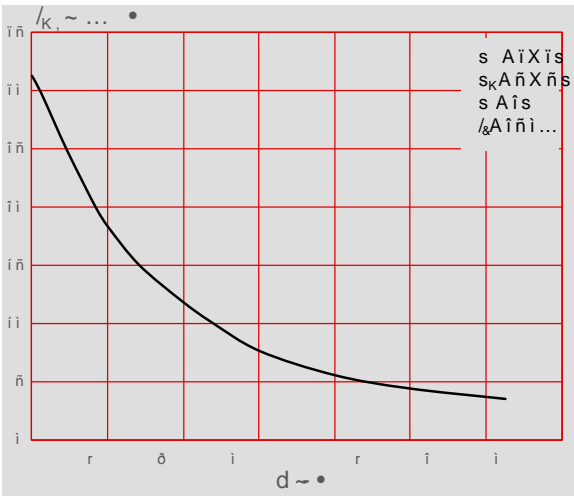

),\* ,QSXW 7KUHVCWOG &\$PELHQW ),\* ,QSXW 7KUHVCWOG &\$PELHQW  
7HP SHUDWXUH 7HP SHUDWXUH



- 2 & + \$ %



-LH-LH 0LFURHOHFWURQL

),\* /RZ /HYHO 2XWSXW &XUUHQW Y,Y\* \$REALHOME • AXWESXW &XUUHQW  
7HPSHUDWXUH

- 2 & + \$ %



-LH-LH 0LFURHOHFWURQL

), \* 3XOVH :LGWK 'LVWRUWLRQ YV), \$ 3XOVH :LGWK 'LVWRUWLRQ YV), \$  
7HPSHUDWXUH 7HPSHUDWXUH

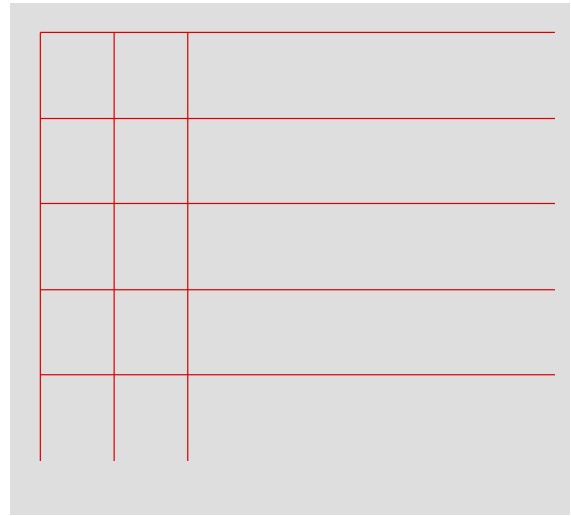
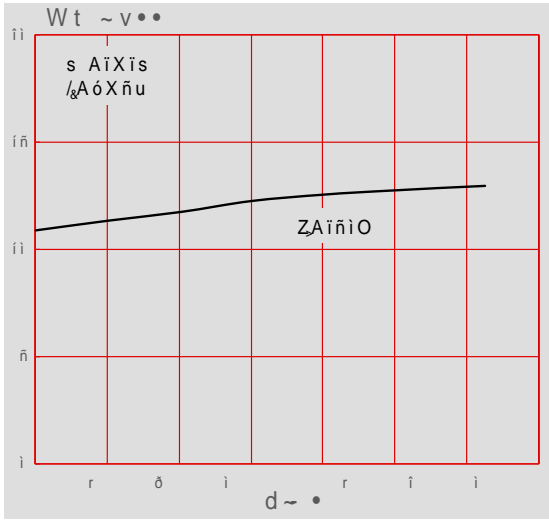



d ^d /Z h/d^

)LJ 6ZLWFKLQJ 7LPH 7HVW &LUFXLW DQG :DYHIRUP

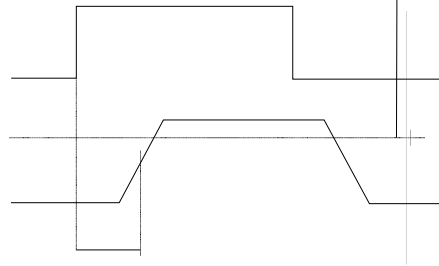
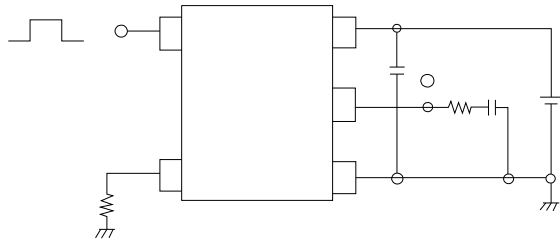

- 2 & + \$ %



- LH-LH 0LFURHOHFWURQL

W I P ]u v•]}v ~hv]šW uu•

> ^KWñ

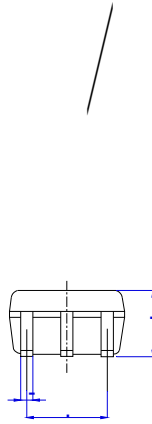
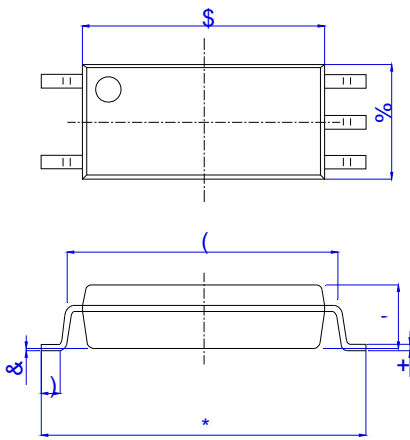

5HI	'LPHQVLRQV					
	0LOOLPHWHUV ,QFKHV					
	0LQ	7\S	0D[	0LQ	7\S	0D[
\$						
%						
&						
,						
(						
)						
*						
+						
,						
-						
.						

> ^KWñ t



Z KDD E ^K> Z D ^< ~ ]u v•]}v• ]v uu μvσ •• }šZ Œ

> ^KW ñ

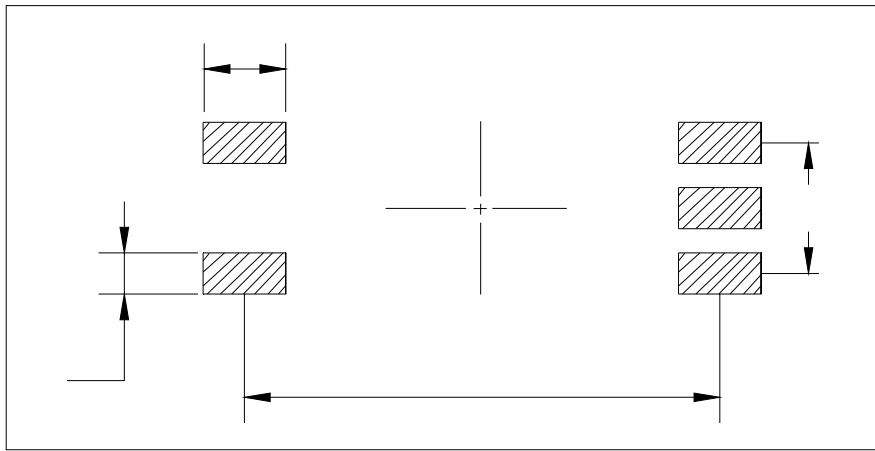

> ^KW ñ t

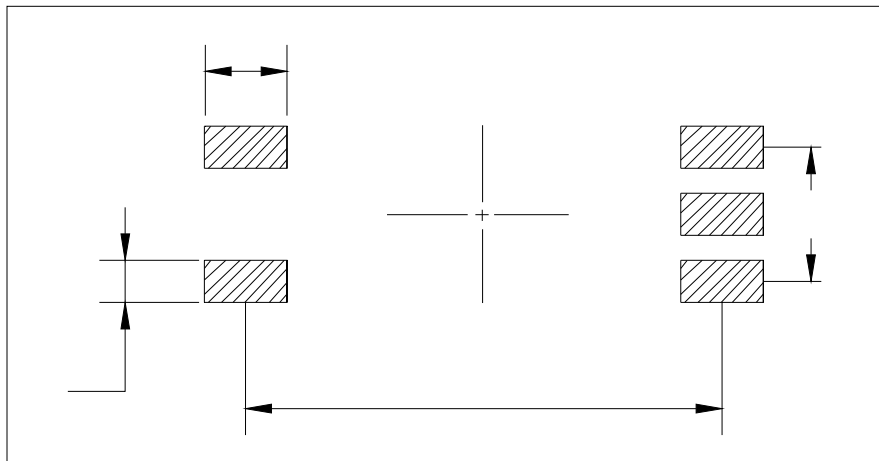

- 2 & + \$ %



- LH-LH 0LFURHOHFWURQL

ZZ/ Z d W ^W /&/ d/KE ^ }v]uu μνo •••ššž ĆÁ]•

K%o š]}v E}v IZ

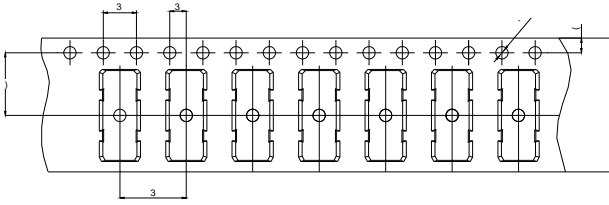

5HI	'LPHQVLRQV					
	0LOOLPHWHUV ,QFKHV					
	0LQ	7\ S	0D[	0LQ	7\ S	0D[
'						
3						
3						
3						
(						
)						
7						
:						

Z >Kt /E&KZD d/KE

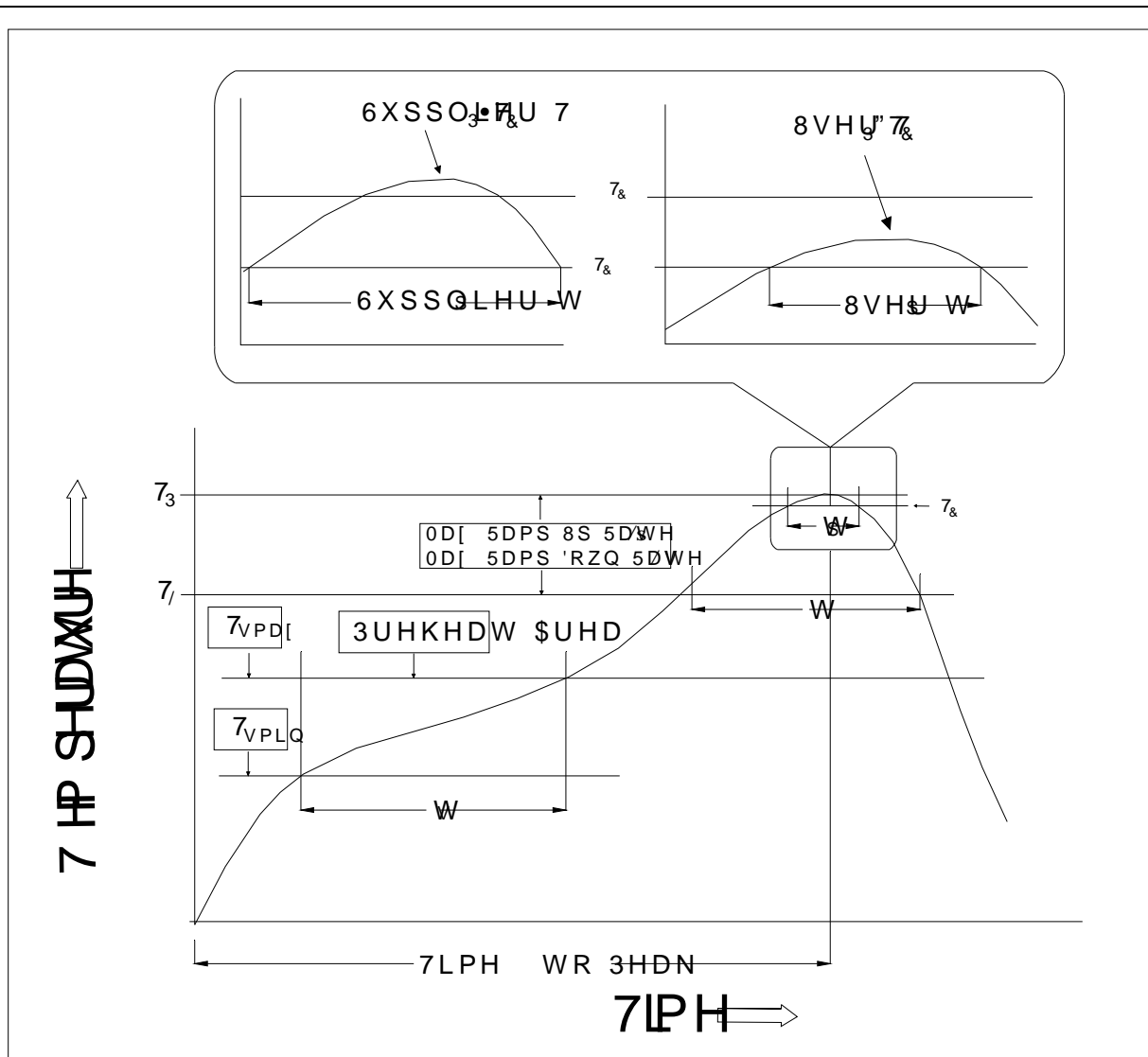

3URILQH )HDWXUH 0D[ 5DPS 8S 5DWH	0D[ 5DPS 'RZQ 5DWH	3URILQH 3E )UHH \$VVH
7HP SHUDWXUH 0LQ 7VPLQ		
7HP SHUDWXUH 0D[ 7VPD[		
7LPH WV IURP 7VPLQ WR 7VPD[		VHFRQG V
5DPS XS 5DWH W/ WR W3/HFRQG PD[		VHFRQG PD[
/LTXLGXV 7HP SHUDWXUH 7/		
7LPH W/ 0DLQWDLQH \$ERYH 7/		VHFRQG V
3HDN %RG\ 3DFNDJH 7HP SHUDWXUH		
7LPH W3 ZLWIKLQ		VHFRQG V
5DPS GRZQ 5DWH 73 WR 7VHFRQG PD[		VHFRQG PD[
7LPH WR 3HDN 7HP SHUDWXUH		PLQXWHLQ R D[HV PD[

1RWH

- 2 & + \$ %



- LH-LH 0LFURHOHFWURQL

5HIORZ VROGHULQJ LV UHFRPPHQGHG/ DWRVZKH QVHPSWKUDWVXUWHFHDV  
\$YRLG GLUHFV FRQVHDIFSRPHFRZOHQWRXUDFRU/ H[FHHGLQJ LWV PD  
VWRUDJH WHPSHUDWXUH

\$SSOLFDWLRQ RKHSHSRVXENRQLWLSOHGDDWHG WHPSHUDWXUHV ,Q V  
VFHQDULRV DQHPSVOLHQRWRHFFHHG 1

(QVXUH WKH FRPSRQHQW KDV FRROHG WRDFHEWKOQZLHRSVHWDVHQL  
PDQXIDFWXULQJ VWHSV

7KH FRPSRQHQW KDM BQMKHODUQKHQVWDRGHGKFRQLGLWLRQV

5HFRPPHQG VWRUDJH 7HPS a f&

5HFRPPHQG VWRUDJH KXPLGLW\

06/ OHYHO 06/

,QIRUPDWLRQ IXUQXPHQW/ LQ VIKOLHGRHG WR EH DFFXUDWH I  
-LDQJVVX -LH-LH 0L&URRHOHWFWDVROXLFHVVQLRVUHRUSRQVHLERQVHT  
RI XVH ZLWKRXW FRQVLGHUDWLRQ IRG MWFKQIQURPDVWLRQ  
LQ WKLV GRFXPHQW LQJYXZLWHFRXWRQRWLFH DSDUW IURP V  
VLJQHGH -LDQJVSOLHVLZILFRKPKKH DJUHHPHQW

3URGXFVW DQG LQIRUPDWLRQ SURYLGHG LQ HQWVVRGSDXPH  
-LDQJVVX -LH-LH DVVXIPHLVQV\URVSRQVLQIULQJHPPHQW RI RW  
ZKLFK PD\ UHVXOW IURP WKH XVH RI VFKLW SURFXPHQW DQGS HL  
DQG UHSODFHV DOO LQIRUPDWLRQ SUHYLRXVO\ VXSSOLHG



LV D UHJLVWHUHGDQJUDXGHLHDUNRUFURHOHFWURQLFV & R  
&RS\ULJKW -LDQJVVX -LH-LH 0LFURHOHFWURQLFV & R

'RFXPHQW 5HJLVLRQ +LVWRU\