



JOC307XD4 Series

Rev.A.1.1

DESCRIPTION:

The JOC307XD4 series combine an AlGaAs infrared emitting diode as the emitter which is optically coupled to a monolithic silicon random-phase photo triac in a plastic DIP4 package with different lead forming options. With the robust coplanar double mold structure, JOC307XD4 series provide the most stable isolation feature. The products are widely used in solenoid/valve controls, lighting controls, motor controls, temperature controls,

	Junction Temperature	T_j	125	
	Output Power Dissipation	P_o	250	mW
	Power Dissipation Derating ($T_a = 25^\circ\text{C}$)	$P_D/$	-3.33	mW/
Total Power Dissipation		P_{tot}	350	mW
Isolation Voltage		V_{iso}	5000	Vrms

Operating Temperature

ORDERING AND MARKING INFORMATION

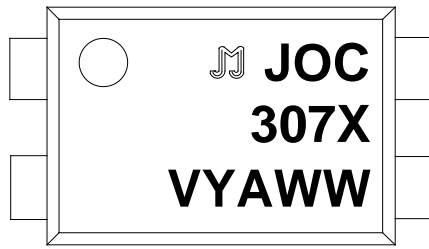
MARKING INFORMATION			
	<p>JOC : Company Abbr. 307X : Part Number & Rank V :</p>		
ORDERING INFORMATION			
JOC307XD4(Y)(Z)-GV			
<p>JOC – Company Abbr. 307X – Part Number (1/2/3) D4 – DIP4 Package Y – Lead Form Option (M/S/SL/SLM/None) Z – Tape and Reel Option (T1/T3) G – Green V – VDE Option (V or None)</p>			
Packing Quantity			
Option	Quantity	Quantity – Inner box	Quantity –Outer box
None	100 Units/Tube	32 Tubes/Inner box	10 Inner box/Outer box =32k Units
M	100 Units/Tube	32 Tubes/Inner box	10 Inner box/Outer box =32k Units
S(T1)	1500 Units/Reel	3 Reels/Inner box	

Characteristics Curves

FIG.1: Forward Current vs. Ambient Temperature

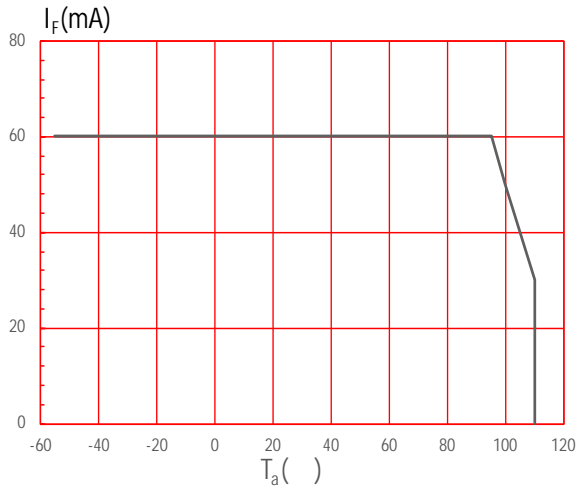
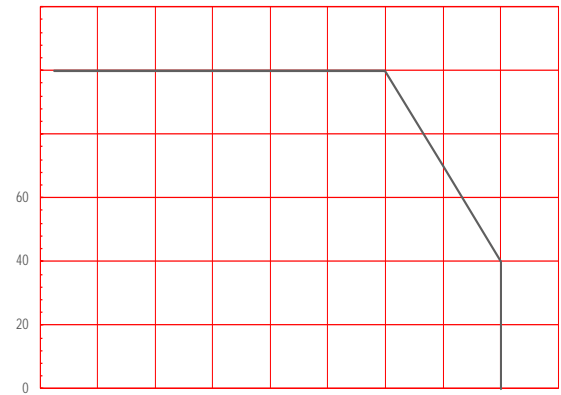

FIG.2: On-state Terminal Current vs. Ambient Temperature



TEST CIRCUITS

FIG.12: Test Circuits of Turn On Time

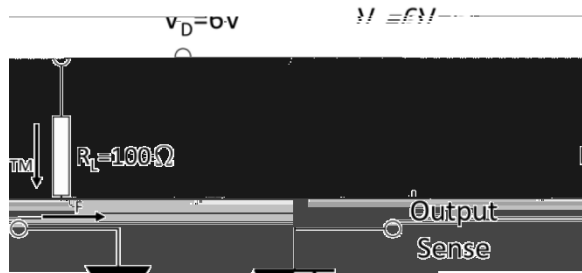

FIG.13: Waveforms of Turn On Time

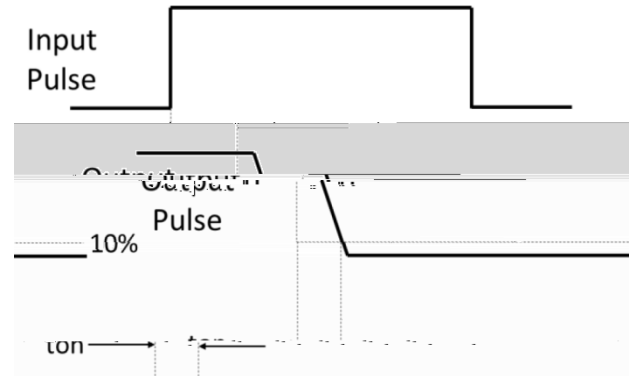

Fig.14: Test Circuits of dV/dt

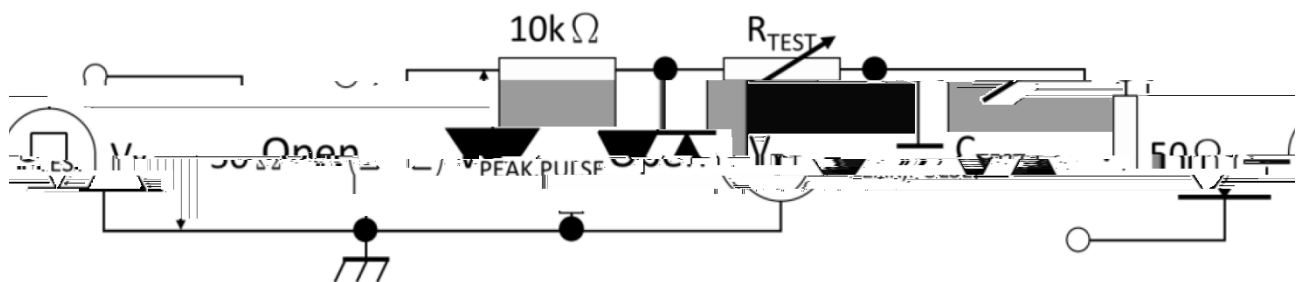
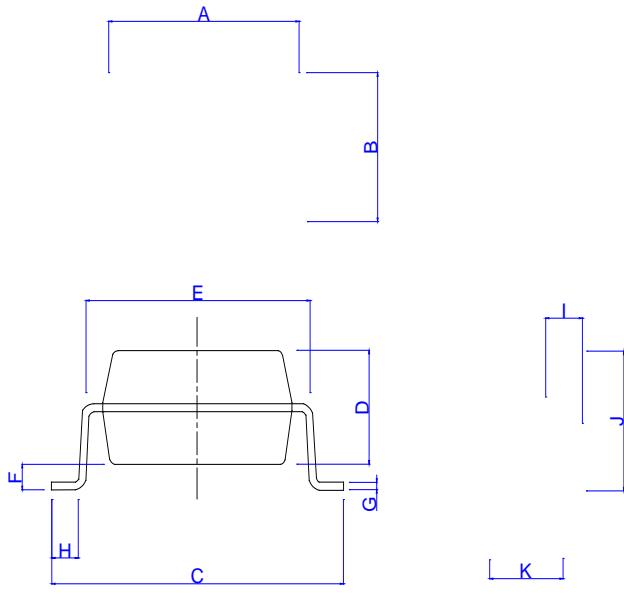

Fig.15: Waveforms of dV/dt





Option S Type:



Ref.	Dimensions					
	Millimeters			Inches		
	Min.	Typ.	Max.	Min.	Typ.	Max.
A	6.30		6.70	0.249		0.265
B	4.38		4.78	0.173		0.189
C	9.85		10.45	0.389		0.413
E	7.32		7.92	0.289		0.313
G						
I						
K						

Option SLM Type:



RECOMMENDED SOLDER MASK (Dimensions in mm unless otherwise stated)

Option S/SL

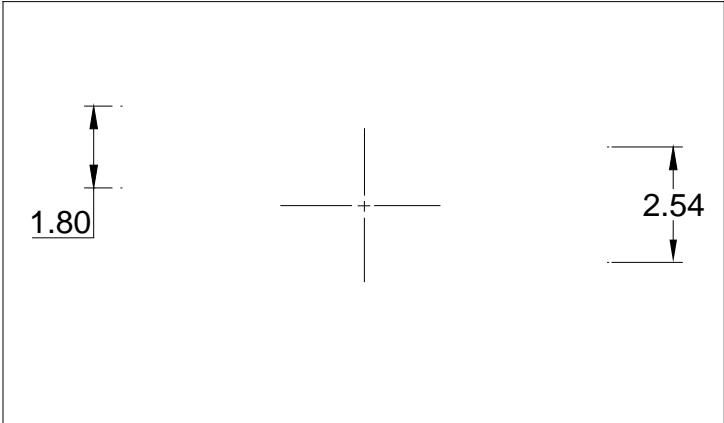

TUBE SPECIFICATIONS (Dimensions in mm unless otherwise stated)

Standard DIP

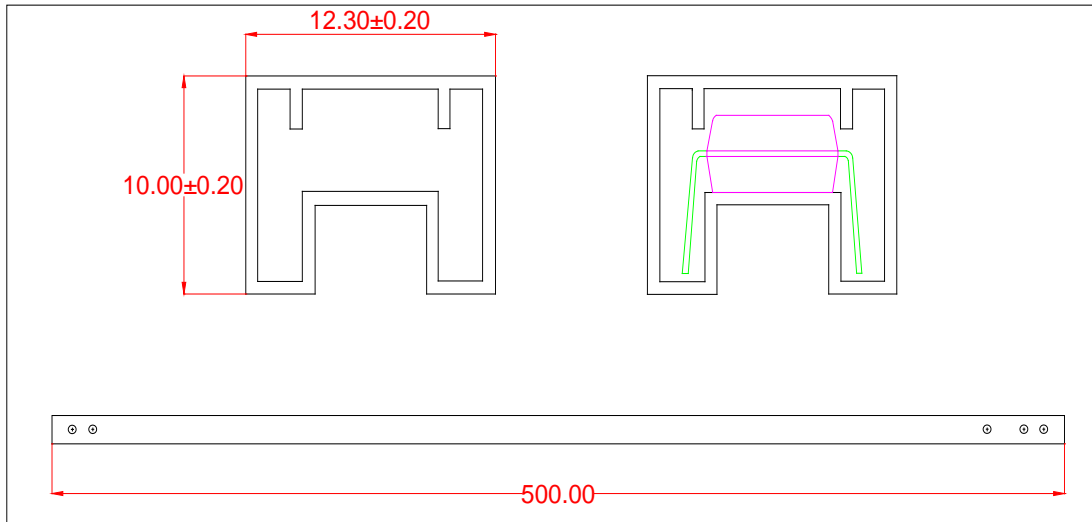

Option M

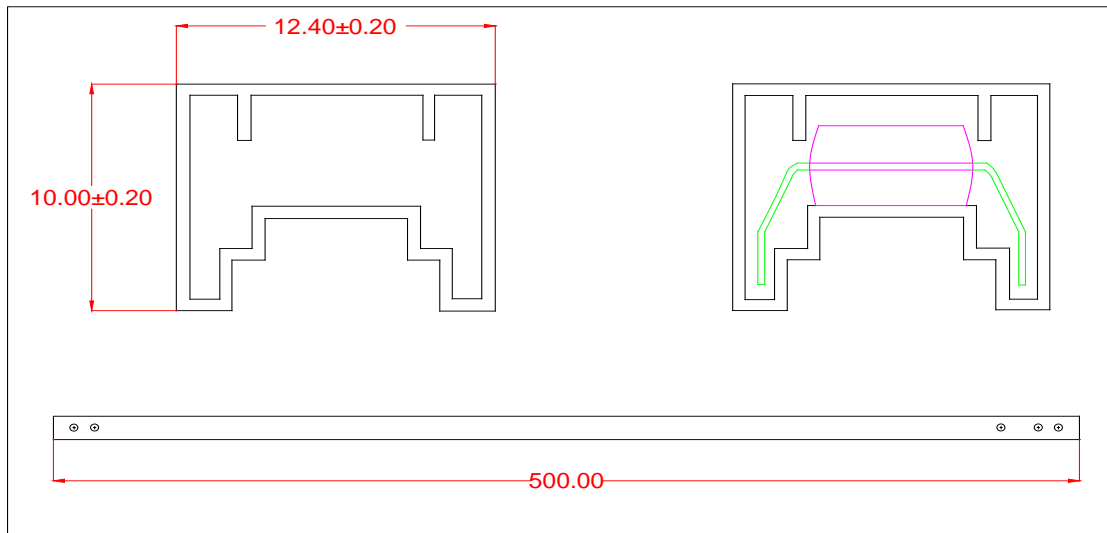

CARRIER TAPE SPECIFICATIONS (Dimensions in mm unless otherwise stated)**Option S(T1)**

Ref.	Dimensions					
	Millimeters			Inches		
	Min.	Typ.	Max.	Min.	Typ.	Max.
D0		1.50			0.059	
P0		4.00			0.157	
P1		8.00			0.315	
P2		2.00			0.079	
E		1.75			0.069	
F		7.50			0.295	
T		0.40			0.016	
W		16.00			0.630	

Option SL(T3)

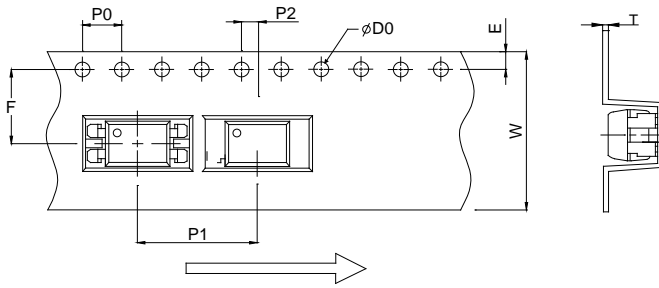

Ref.	Dimensions					
	Millimeters			Inches		
	Min.	Typ.	Max.	Min.	Typ.	Max.
D0		1.50			0.059	
P0		4.00			0.157	
P1		12.00			0.472	
P2		2.00			0.079	
E		1.75			0.069	
F		7.50			0.295	
T		0.40			0.016	
W		16.00			0.630	

Document Revision History

Date	Revision	Changes
Apr.2, 2025	A.1.0	Last update
Nov.5, 2025	A.1.1	Add SLM package

Information furnished in this document is believed to be accurate and reliable. However, Jiangsu JieJie Microelectronics Co., Ltd. assumes no responsibility for the consequences of use without consideration for such information nor use beyond it. Information mentioned in this document is subject to change without notice, apart from that when an agreement is signed, Jiangsu JieJie complies with the agreement.

Products and information provided in this document have no infringement of patents. Jiangsu JieJie assumes no responsibility for any infringement of other rights of third parties which may result from the use of such products and information. This document supersedes and replaces all information previously supplied.



is a registered trademark of Jiangsu JieJie Microelectronics Co., Ltd.

Copyright © 2025 Jiangsu JieJie Microelectronics Co., Ltd. All rights reserved.