

Typical Electrical & Thermal Characteristics

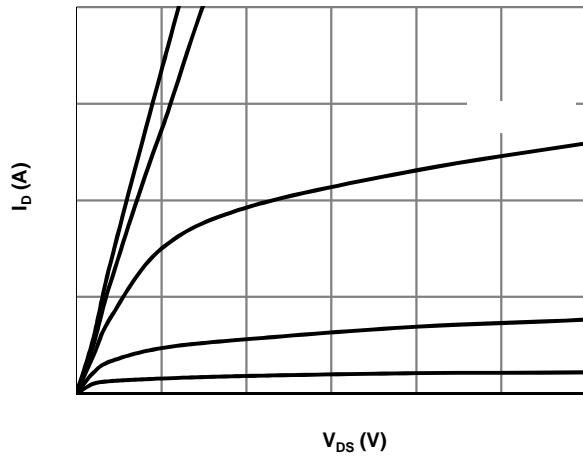
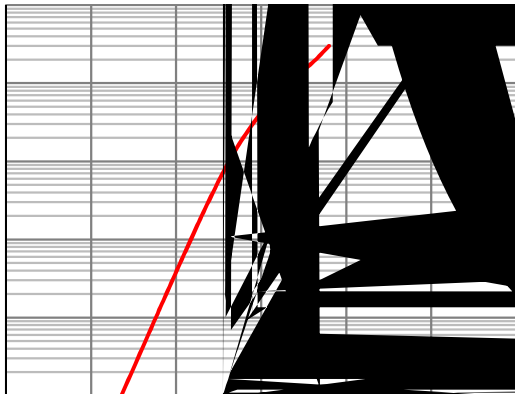

Figure 1: Saturation Characteristics





Typical Electrical & Thermal Characteristics

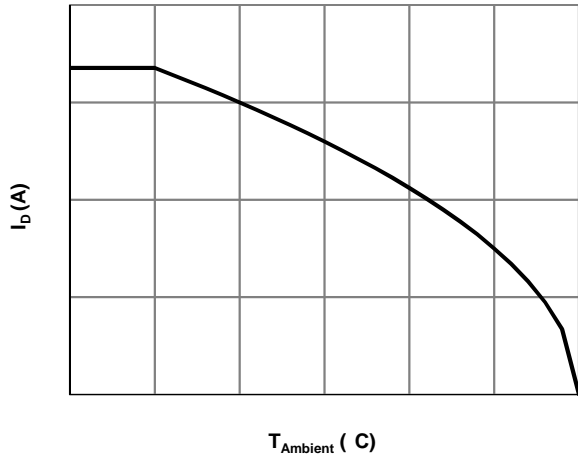

Figure 7: Current De-rating

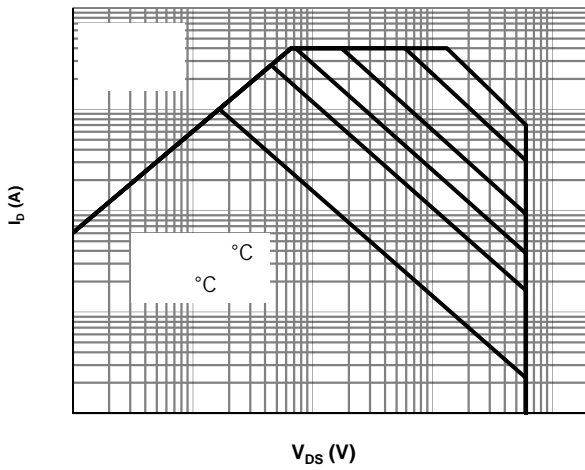
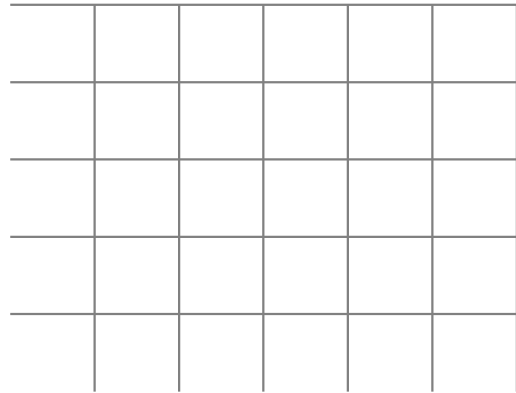
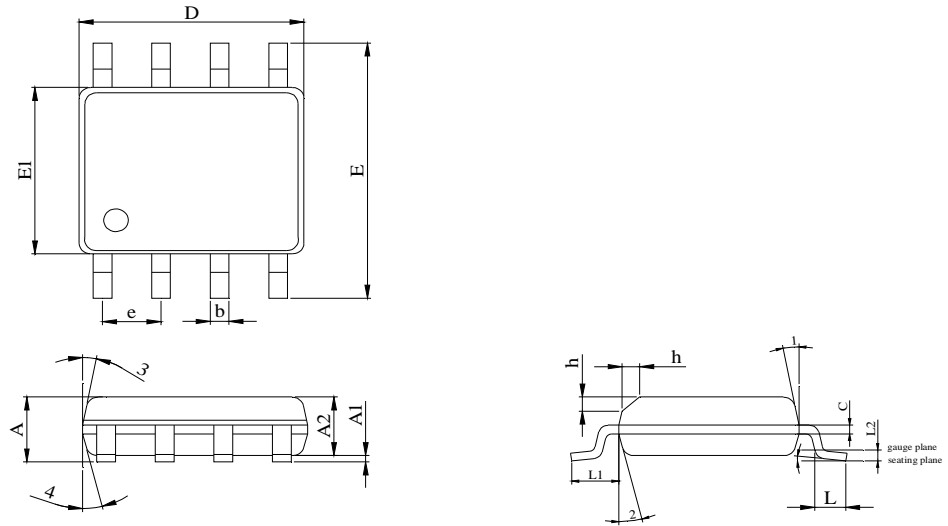

Figure 9: Maximum Safe Operating Area



SOP-8L Package Information

Package Outline



DIM	MILLIMETER		
	MIN.	NOM.	MAX.
A	1.35	1.50	1.65
A1	0.05	0.10	0.15
A2	1.35	1.40	1.50
b	0.38	--	0.50
c	0.17	--	0.25
D	4.80	4.90	5.00
E	5.80	6.00	6.20
E1	3.80	3.90	4.00

Recommend Soldering Footprint

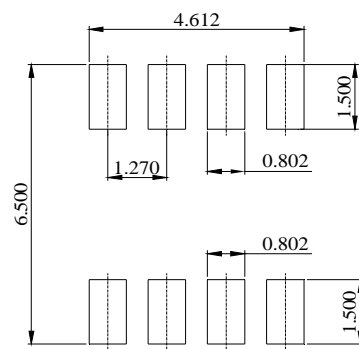

DIMENSIONS: MILLIMETERS